

INSTALLATION INSTRUCTIONS



OUTLAW RUNNING BOARDS

APPLICATION:

2019-2023 Chevrolet/GMC Silverado/Sierra 1500 Crew Cab
2020-2023 Chevrolet/GMC Silverado/Sierra 2500/3500 Crew Cab

PART NUMBER:

28-31275

CONTENT			
ITEM	QUANTITY	DESCRIPTION	TOOLS NEEDED
1	1	DRIVER RUNNING BOARD	TORQUE WRENCH
2	1	PASSENGER RUNNING BOARD	RATCHET
3	3	DRIVER SIDE BRACKET	13MM WRENCH
4	3	PASSENGER SIDE BRACKET	13MM SOCKET
5	12	M8 HEX HEAD CAP SCREW	16MM WRENCH
6	12	M8 SPLIT LOCK WASHER	16MM SOCKET
7	12	M8 FLAT WASHER	
8	12	M10 SERRATED FLANGE HEX HEAD BOLT	
9	12	M10 SERRATED FLANGE NUT	

ANTI-SEIZE LUBRICANT MUST BE USED ON ALL STAINLESS STEEL FASTENERS TO PREVENT THREAD DAMAGE AND GALLING

Item 1

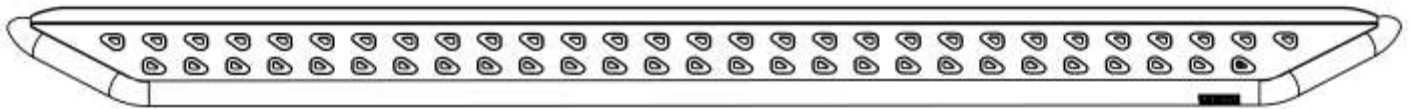

Item 2

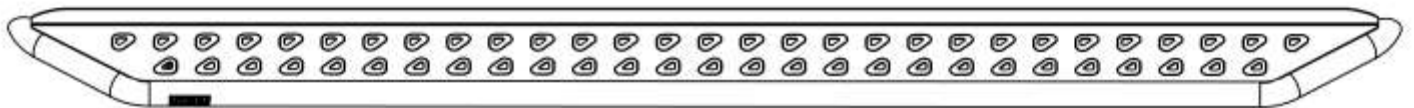

Item 3

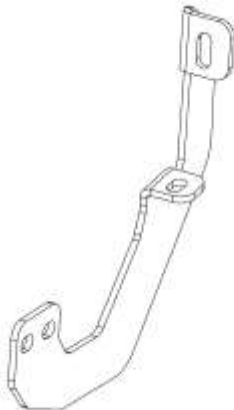

Item 4



Westin Automotive Products, Inc.
320 W. Covina Blvd
San Dimas, Ca. 91773

Thank you for choosing Westin products
for additional installation assistance please call
Customer Service (800) 793-7846
www.westinautomotive.com

PROCEDURE

1. Remove contents from box, verify if all parts listed are present and free from damage.
Carefully read and understand all instructions before attempting installation.
Failure to identify damage before installation could lead to a rejection of any claim.
2. Starting on the driver side, remove the rubber plugs located on the rocker panel at each mounting location. See **Figure 1** for reference..
3. **For models with threaded holes:** At each bracket mounting location on the rocker panel there should be a welded factory nut.



Figure 1

4. At the front driver side location, loosely install the Driver Side Bracket (**Item 3**) with the supplied M8 hardware (**Item 5, 6, & 7**). See **Figures 2 & 3** for reference.
5. At the center driver side location, loosely install the Driver Side Bracket (**Item 3**) with the supplied M8 hardware (**Item 5, 6, & 7**). See **Figure 4** for reference.
6. At the rear driver side location, loosely install Driver Side Bracket (**Item 3**) with the supplied M8 hardware (**Item 5, 6, & 7**). See **Figure 5** for reference.

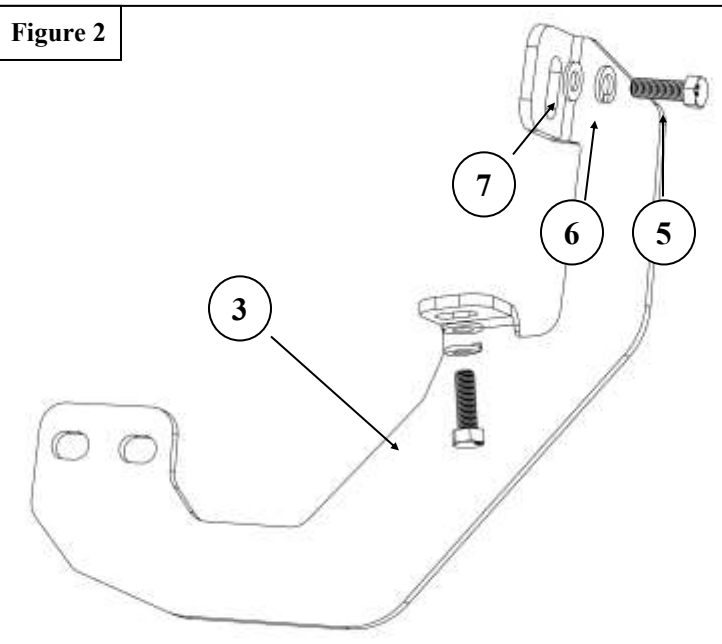

Figure 2

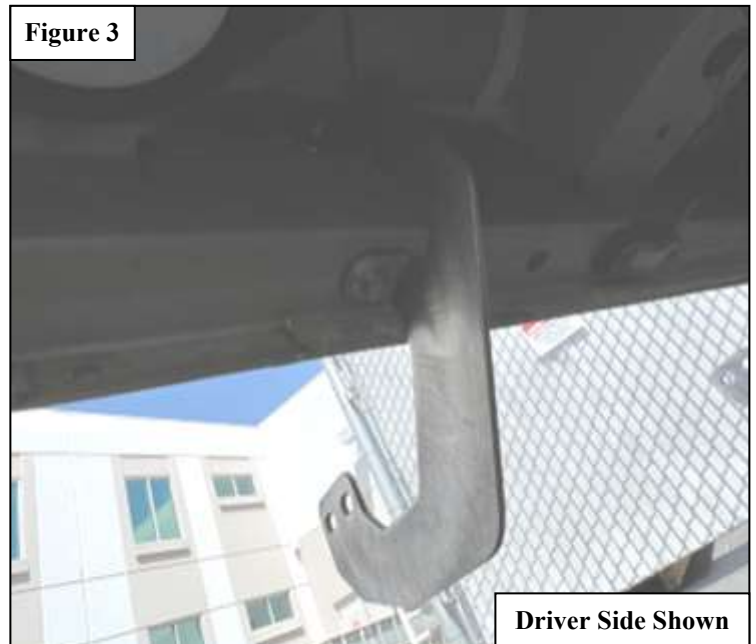

Figure 3

Driver Side Shown

WESTIN

Westin Automotive Products, Inc.
320 W. Covina Blvd
San Dimas, Ca. 91773



7. Using the hardware provided (**Items 8 & 9**), loosely attach the Driver Running Board to the previously mounted brackets. See **Figure 6** for reference.
8. Repeat **Steps 4 through 7** on the passenger side of the vehicle with the appropriate brackets and hardware. See **Figures 7 & 8** for reference.
9. Align and adjust the Outlaw Running Boards and brackets as needed and fully tighten all hardware. Torque all M8 hardware to 15-18 ft-lbs. and all M10 hardware to 35-38 ft-lbs.

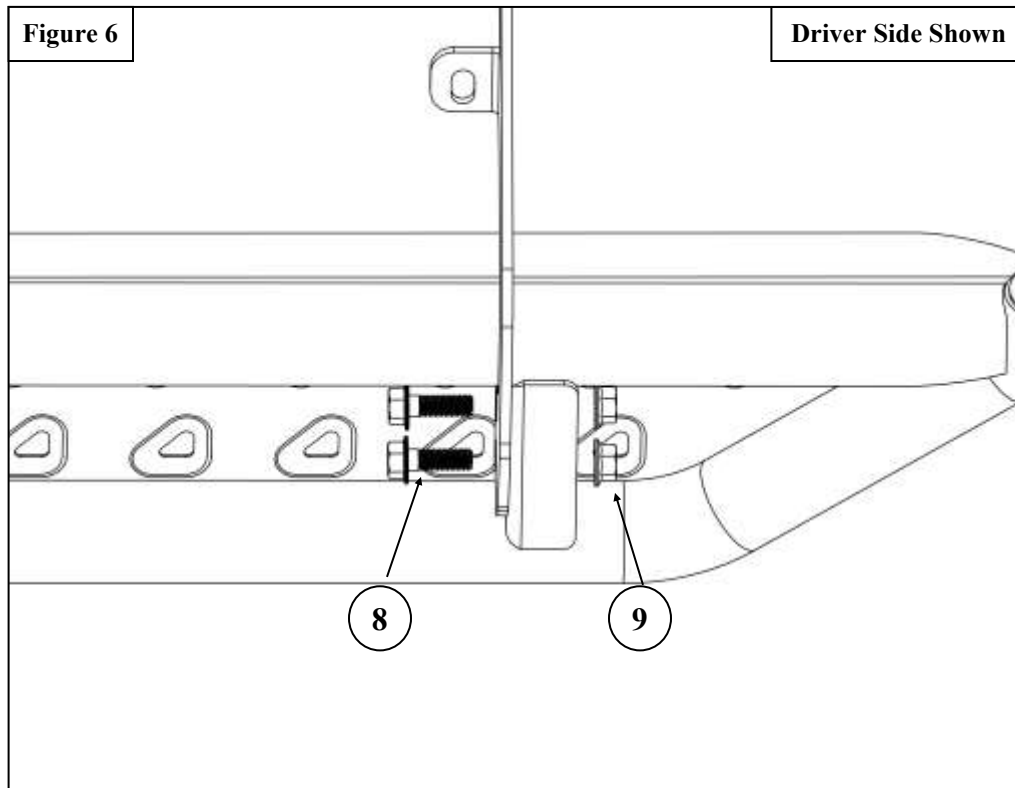

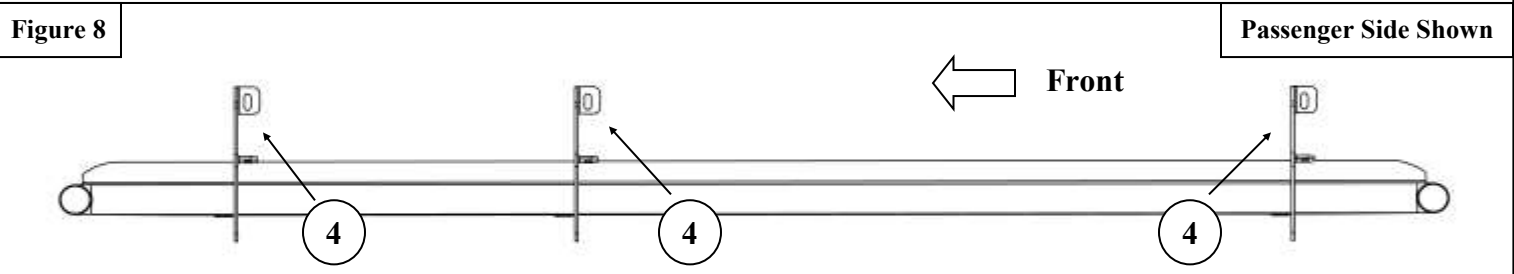
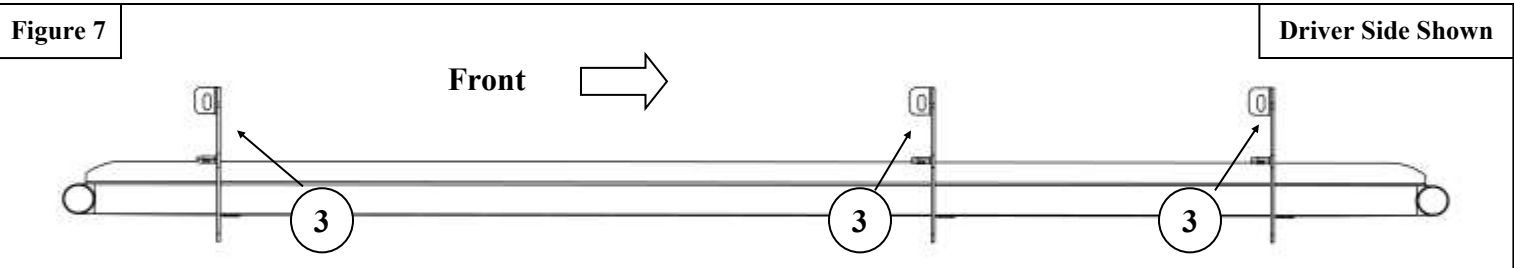

INSTALLATION COMPLETE



CARE INSTRUCTIONS

- REGULAR WAXING IS RECOMMENDED. DO NOT USE ANY TYPE OF POLISH OR WAX THAT MAY CONTAIN ABRASIVES.
- STAINLESS STEEL PRODUCTS CAN BE CLEANED WITH MILD SOAP AND WATER. STAINLESS STEEL POLISH SHOULD BE USED TO POLISH SMALL SCRATCHES.
- GLOSS BLACK FINISHES SHOULD BE CLEANED WITH MILD SOAP AND WATER.



WARNING



Failure to follow these instructions could lead to death, personal injury, and / or property damage.

Failure to follow these instructions could lead to death, personal injury, and / or property damage.

FASTENERS:

All Westin supplied fasteners must be utilized and installed in accordance with the installation instructions and apply torque to the specifications as defined. **DOUBLE CHECK ALL FASTENERS BEFORE INITIAL USE, AND PERIODICALLY IN THE FUTURE TO ENSURE PROPER FUNCTION AND SAFETY.**

DRILLING:

Most Westin products do not require drilling for installation. If drilling is defined as required, use caution when drilling a vehicle. **FAILURE TO REVIEW AN AREA TO BE DRILLED MAY RESULT IN PERSONAL INJURY AND/OR INJURY TO OTHERS AS WELL AS VEHICLE DAMAGE.**

EYE PROTECTION:

ALWAYS WEAR SAFETY GLASSES OR GOGGLES DURING THE INSTALLATION PROCESS TO AVOID PERSONAL INJURY.

MAXIMUM TOWING/CARRYING CAPACITY: (if applicable)

The Westin Receiver Hitches will have a visible tow rating label affixed directly on the product. User should never exceed the vehicle manufacturers maximum tow and weight rating regardless of the capacity of the hitch. **FAILURE TO FOLLOW THESE GUIDELINES WILL VOID THE WESTIN WARRANTY AND MAY RESULT IN PERSONAL INJURY AND/OR INJURY TO OTHERS AS WELL AS VEHICLE DAMAGE.**

FOR CALIFORNIA RESIDENTS ONLY-PROP 65 WARNING:

Some products may contain chemicals such as DEHP, which can cause cancer, birth defects or other reproductive harm. For more info go to www.p65warnings.ca.gov



Westin Automotive Products, Inc.
320 W. Covina Blvd
San Dimas, Ca. 91773